

# ОПТИВОХ E-14D

Сеть 400В, 50Гц, 3P+N+PE

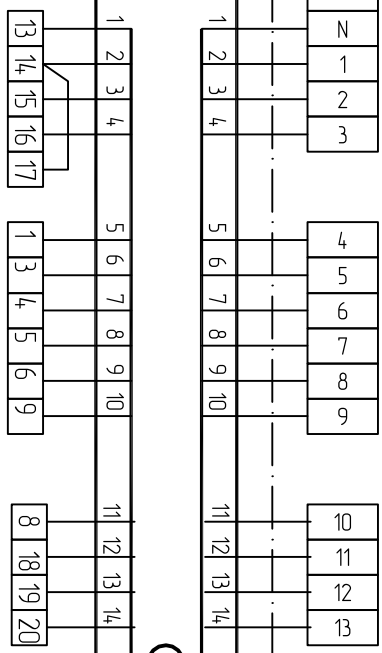

Контроллер ELECTROTEST модель OPTIMUS 7-B

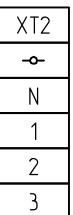
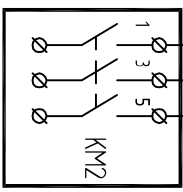
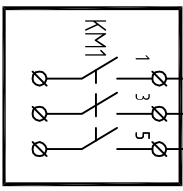
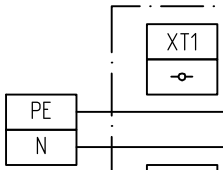
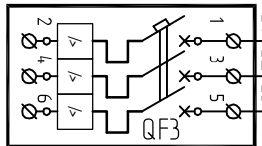
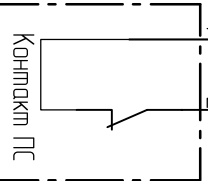



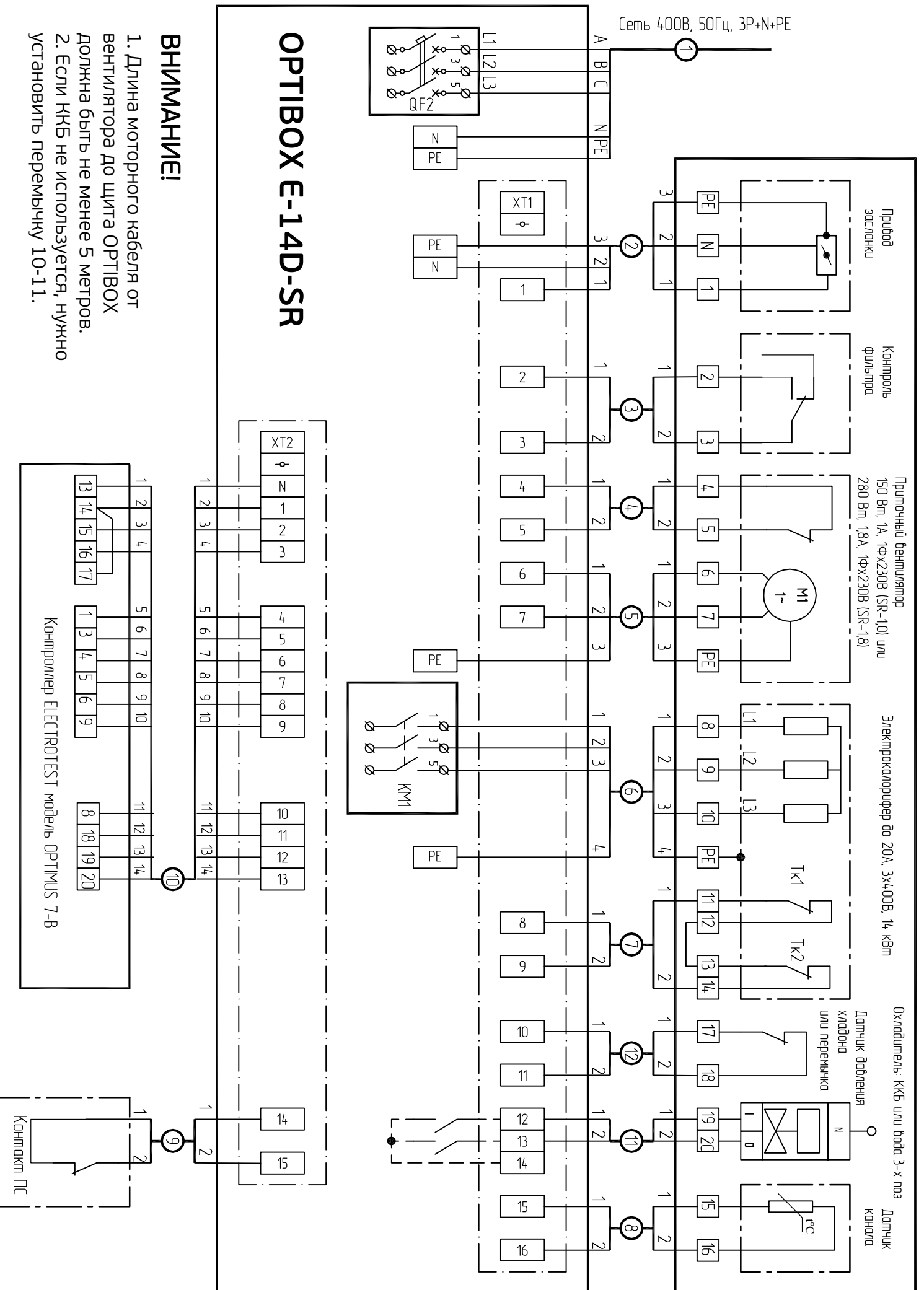

Главный  
эс/лонку

Контроль  
фильтра

Примочный вентилятор  
150 Вт, 1А, 1ФХ230В (SR-10) или  
280 Вт, 1,8А, 1ФХ230В (SR-18)

Электромотор для 20А, 3х400В, 14 кВт

Датчик обдувания  
хладагента  
или переключатель

Охладитель: КК5 или вода 3-х поз

Датчик  
конденсата

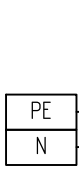
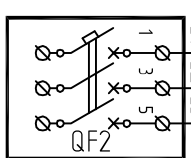

# ОПТИВОХ E-14D-SR

## ВНИМАНИЕ!

1. Длина моторного кабеля от вентилятора до щита ОПТИВОХ должна быть не менее 5 метров.
2. Если ККБ не используется, нужно установить перемычку 10-11.

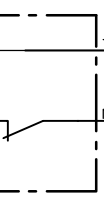
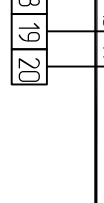
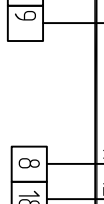
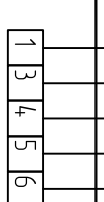
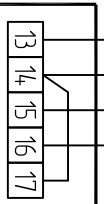
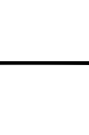
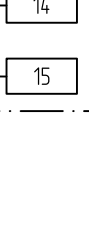
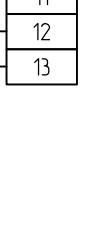
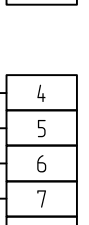
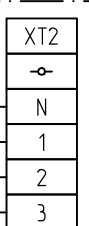

Контроллер ELECTROTEST модель OPTIMUS 7-B

